

Features & Accessories

- Thermal-Magnetic 250 A through 400 A
- Suitable for Branch Circuit Protection
- Rated Current of 250 to 400 A, Max. 600 Vac
- UL489 Listed for use on UL508 Control Panels
- Shunt Trip, Undervoltage Release and Other Accessories available.
- Line and Load Lug Terminals included on All MCCBs
- Toggle Handle provides Three Positions (On/Off and Tripped)
- HACR (Heating, Air Conditioning and Refrigeration Rated)
- Auxiliary Switch, Alarm Switch, Shunt Trip and Undervoltage Release can be installed in the field.
- Door-Mounted or Flange-Mounted, Flex Shaft Operating Handles
- All Frame Sizes Suitable For Reverse-Feed Applications
- All Breakers include Mounting Hardware



UL Listings

- UL489 MCCB, File E231289
- UL489 Circuit-Breaker Accessories, File E223241

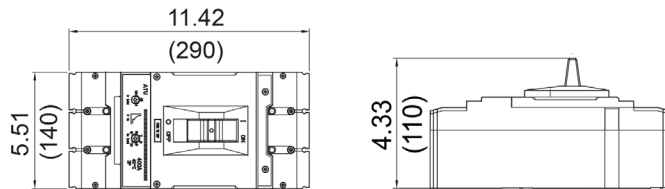

General Specifications

Rated Current (A)	Type	Number of Poles	UL489 Rated Voltage (Vac)	UL489 Interrupting Capacity (kA rms) AC(50/60Hz) 480 Vac	Wire Size (AWG) (CU)	Torque (Lb-In)	Approx. Weight (Lbs.)
UTS400 Frame							
250	UTS400N-FTU-250-3P-LL-UL	3	600	35	1/0-300MCM	358.5	13.89
300	UTS400N-FTU-300-3P-LL-UL						
350	UTS400N-FTU-350-3P-LL-UL				350-600MCM	478	
400	UTS400N-FTU-400-3P-LL-UL						
Trip Unit: Fixed Thermal/Fixed Magnetic; Terminals: Lugs on Line and Load Sides; Compact Wire Only (700-750 MCM); Frame (Width x Height x Depth mm/in): 140/5.51 x 290/11.42 x 110/4.33							

Handles

UL489 Extended Disconnect Handles

- Mechanism for mounting on outside of enclosure
- Padlockable provision for safety lockout
- Shafts can be cut to length to fit your enclosure
- Choose from UL Type 1, 12 or UL Type 3, 4, 4X

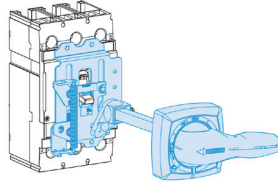

Type 1, 12	Type 3, 3R, 4	Type 3, 4, 4x	Used with MCCB:
EHUOC-12	EHVOC-12	EHXOC-12	UTE100
EHUOC-16/24	EHVOC-16/24	EHXOC-16/24	
EHU2-12	EHV2-12	EHX2-12	UTS150, UTS250
EHU2-16/24	EHV2-16/24	EHX2-16/24	
EHU3-12	EHV3-12	EHX3-12	UTS400, UTS600
EHU3-16/24	EHV3-16/24	EHX3-16/24	
EHU5-12	EHV5-12	EHX5-12	UTS800, UTS1200
EHU5-16/24	EHV5-16/24	EHX5-16/24	

Flange-Mounted Cable Operating Handles

- Cable-operated disconnect handle for flange mount
- Flexible cable allows for easy installation
- Padlockable for safety lockout
- Cable lengths available: 36, 48, 60, 72, 84, & 128"
- Cable sold separately
- Choose from UL Type 1, 12, 3R, 4, 12 or UL Type 4, 4X

Type 1, 3, 3R, 4, 12	TYPE 4, 4X	Used with MCCB:
COM0/FHU-S	COM0/FHX-S	UTE100
COM2/FHU-S	COM2/FHX-S	UTS150, UTS250
COM3/FHU-L	COM3/FHX-L	UTS400, UTS600
COM5/FHU-L	COM5/FHX-L	UTS800, UTS1200

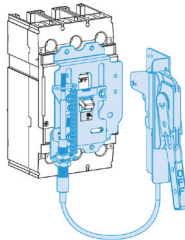

Flange Cables

Part #:	Cable Length (Inch):	Used with MCCB:
FH2-36	36	UTE100, UTS150, UTS250
FH2-48	48	
FH2-60	60	
FH4-36	36	UTS400, UTS600
FH4-48	48	
FH4-60	60	
FH4-72	72	UTS800, UTS1200
FH5-60	60	
FH5-84	84	
FH5-128	128	

Locking Devices

Removable Locking Device

- Easily attaches to the MCCB
- Allows handle to be locked in "OFF" position which guarantees isolation according to UL489
- 3 padlocks may be used with shackle diameters ranging from 0.2" - 0.3" (not supplied)

Mechanical Interlock Device

- Device locks two breakers together and provides 3 positions: Left Off - Right On, Left On - Right Off, and Left Off - Right Off
- Front interlocking plate allows installation of a padlock (not supplied) in order to fix the position. Two padlocks may be used to fix Left Off - Right Off

Fixed Plate Locking Device

- Easily attaches to the MCCB
- Allows handle to be padlocked in "ON" or "OFF" position. Locking in "OFF" position guarantees isolation according to IEC 60947-2

Part Number:	Used with MCCB:
Pad Lock	
PL0	UTE100
PL2	UTS150, UTS250
PL3	UTS400, UTS600
PL5	UTS800, UTS1200
Pad Handle Lock	
PHL0	UTE100
PHL2	UTS150, UTS250
PHL3	UTS400, UTS600
PHL5	UTS800, UTS1200
Mechanical Interlock	
MIT03	UTE100
MIT23	UTS150, UTS250
MIT33	UTS400, UTS600
MIT53	UTS800, UTS1200

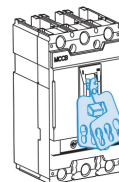

Removable Locking Device

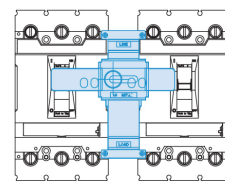

Mechanical Interlock Device

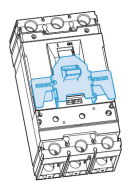

Fixed Plate Locking Device

Internal Modules

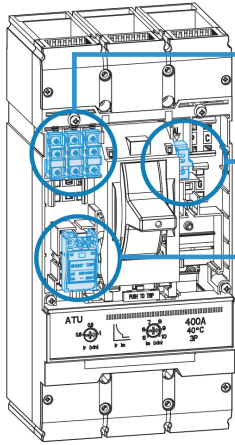

Module Options

Auxiliary Switch (AX)

- Provides remote "On" and "Off" indication

Alarm Switch (AL)

- Provides immediate indication of a breaker trip.

Shunt and Undervoltage Trips (SHT) & (UVT)

- (SHT) - Opens breaker in response to externally applied voltage signal.
- (UVT) - Automatically trips when control voltage drops. Breaker cannot be closed again until voltage returns to 85% of control voltage.

Auxiliary and Alarm Switch Modules

Part #:	Used on MCCB:	Side:	Contact Rating:	Configuration:
Auxiliary Switch Modules				
AX-0-R	UTE100	Left	5A @ 125Vac 3A @ 250Vac 0.4A @ 125Vdc 0.2A @ 250Vdc	SPDT (1NO, 1NC)
AX-0-T		Right		
AX-AL-0-T		Right		
AX	UTS150-600	-		
AX-5	UTS800-1200	-		
Alarm Switch Modules				
AL0-R	UTE100	Left	5A @ 125Vac 3A @ 250Vac 0.4A @ 125Vdc 0.2A @ 250Vdc	SPDT (1NO, 1NC)
AL0-T		Right		
AL	UTS150-600	-		
AL-5	UTS800-1200	-		

Shunt Trip Modules

Part #:	Control Voltage (Vn)	Current:	Operating Voltage:	Used on MCCB:
SHT-0-12	12 Vac/dc	30mA	AC: 0.7-1.1Vn DC: 0.8-1.1Vn	UTE100
SHT-0-24	24 Vac/dc	27mA		
SHT-0-100	110-130 Vac/dc	5.8mA		
SHT-0-200	200-250 Vac/dc	5.4mA		
SHT-0-440	440-500 Vac/dc	3.5mA		
SHT-12	12 Vdc	30mA	AC/DC: 0.7-1.1Vn	UTS150 UTS250 UTS400 UTS600
SHT-24	24 Vac/dc	24mA		
SHT-110	110-130 Vac/dc	10.5mA		
SHT-220	220-240 Vac, 250 Vdc	7.5mA		
SHT-380	380-500 Vac/dc	2.3mA		
SHT-5-24	24-30 Vdc	Power Consumption 200W Inrush 5W Steady-State	0.6-1.1Vn	UTS800 UTS1200
SHT-5-100	110-130 Vac/dc		0.56-1.1Vn	
SHT-5-200	200-250 Vac/dc			
SHT-5-440	380-480 Vac/dc			

Possible Configuration of Internal Modules

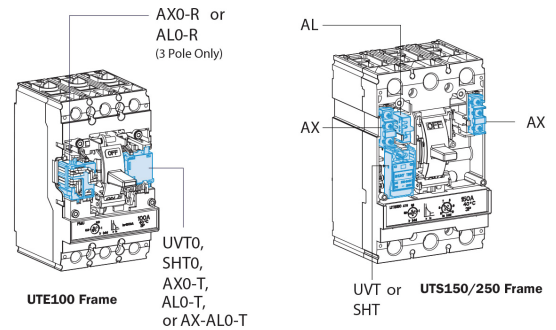

Undervoltage Release Modules

Part #:	Control Voltage (Vn)	Current:	Tripping Voltage:	Used on MCCB:
UVT-0-24	24 Vac/dc	27mA	0.20-0.70Vn	UTE100
UVT-0-100	110-110 Vac/dc	5.8mA		
UVT-0-200	200-220 Vac/dc	5.4mA		
UVT-0-440	440-480 Vac/dc	3.5mA		
UVT-24	24 Vac/dc	27mA	0.35-0.70Vn	UTS150 UTS250 UTS400 UTS600
UVT-100	110-130 Vac/dc	5.8mA		
UVT-200	220-240 Vac, 250 Vdc	5.4mA		
UVT-440	440-480 Vac/dc	3.5mA		
UVT-5-24	24-30 Vdc	Power Consumption 200W Inrush 5W Steady-State	0.44-0.60Vn	UTS800 UTS1200
UVT-5-100	110-130 Vac/dc			
UVT-5-200	200-250 Vac/dc			
UVT-5-440	380-480 Vac/dc			

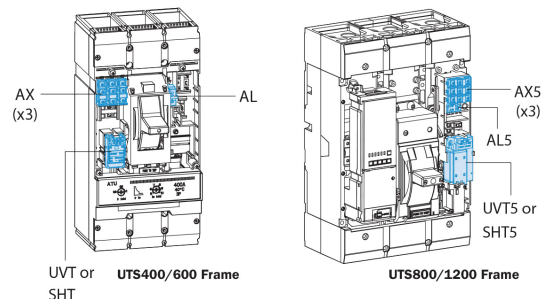

UTS400 CHARACTERISTIC

This curve is to be used for application and coordination purposes only.
All time/current characteristic curve data is based on 40°C ambient cold start.

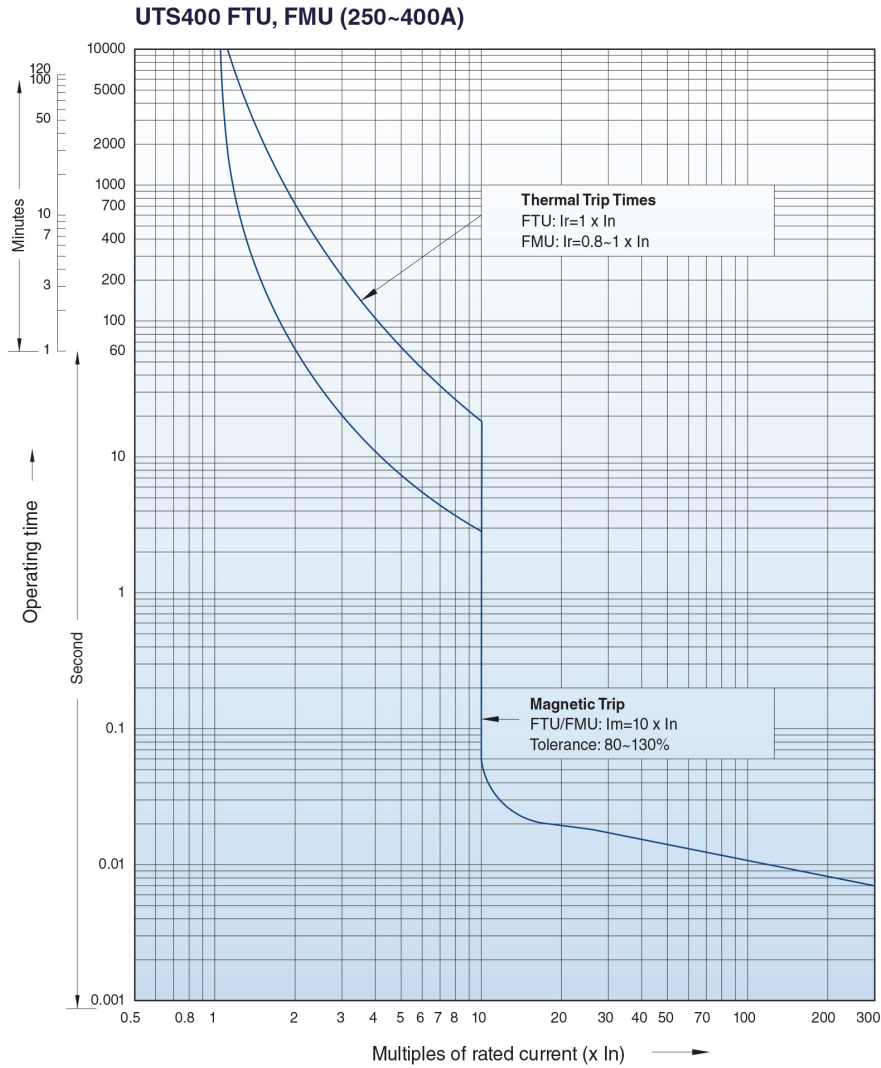

RATING UTS400	FTU	
	2P/3P	MAG TRIP (80%~130%)
250	<input type="radio"/>	2500A
300	<input type="radio"/>	3000A
350	<input type="radio"/>	3500A
400	<input type="radio"/>	4000A

RATING UTS400	FMU		
	2P/3P	RATING RANGE (0.8~1xIn)	MAG TRIP (80%~130%)
300	<input type="radio"/>	240~300A	3000A
400	<input type="radio"/>	320~400A	4000A